



DM-200B

ICE AND WATER DISPENSER



DM-200B
02/21/19
Item # 13051

Item #: _____
Project: _____
Qty: _____
AIA#: _____

Features

- ▶ Durable stainless steel exterior
- ▶ Unique auger agitator design dispenses individual cubes
- ▶ Accommodates ice machine or manual fill

- Built-in storage capacity of 5.72ft³/200 lbs.*
- Dispenses ice and water with the touch of a button
- Dispenses 7.5 lbs. of ice per minute
- Dispenses ice and water
- 8 ft. power cord with NEMA 5-15P plug
- Optional 4" legs

Warranty:

3 Year Parts & Labor on entire machine. Valid in United States, Canada, Puerto Rico and U.S. Territories. Contact factory for warranty in other countries.

* Capacity based on volume x 30 lb/ft³ average density of ice.

W x D x H
30" x 28" x 36^{3/8}"

SD-200
30" x 28" x 32^{13/16}"

DM-200B
Shown with optional
KML-500MAJ Ice Machine



Model	Exterior Dimensions	Interior Dimensions	Agitator	Max. Fuse Size or HACR Circuit Breaker	Amperage	Voltage	Shipping Weight
DM-200B	30 ^{3/10} " x 28" x 36 ^{3/8} "	23" x 22 ^{3/8} " x 22 ^{1/2} "	14.5" diameter	15A	4.1A	115V/60/1	240 lbs.

Power cord included.

Operating Limits

- Ambient Temp Range 45 - 100°F
- Water Temp Range 45 - 90°F
- Water Pressure 10 - 113 PSIG
- Voltage Range 104 - 132V

Options

- 4" leg kit
- Top Kit (HS-2036) - to accommodate KM-340, KM-515M, or KM-650M ice machines

Service

- If dispenser is to be permanently installed, allow a minimum clearance of 6" (15 cm) on the right side, for access to service the drive mechanism. Allow a minimum clearance of 24" (60 cm) above the dispenser for easy filling with ice.
- Panels easily removed and all components accessible for service.

Plumbing

- Water supply line: Minimum 1/8" Nominal ID Copper Water Tubing or Equivalent
- Drain line: Minimum 3/4" Nominal ID Hard Pipe or Equivalent



DM-200B

ICE AND WATER DISPENSER



DM-200B
02/21/19
Item # 13051

FRONT VIEW

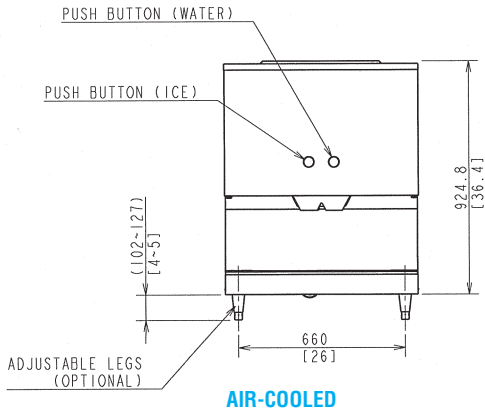

mm
[inch]

SIDE VIEW

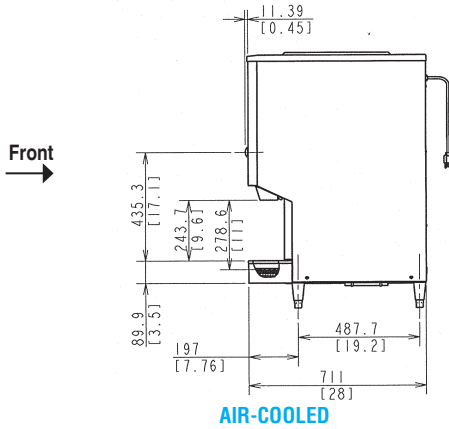

REAR VIEW

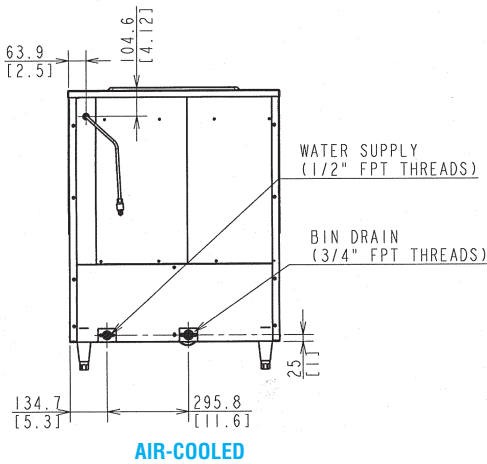

TOP VIEW

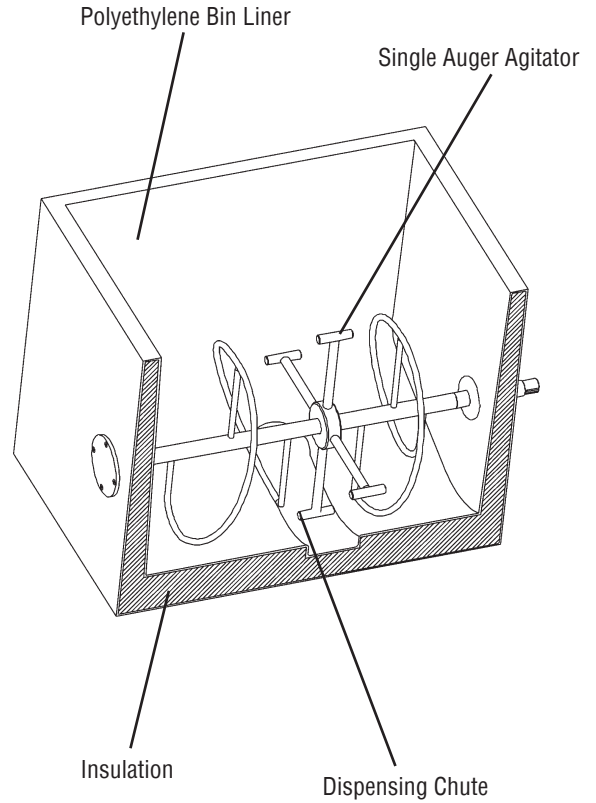
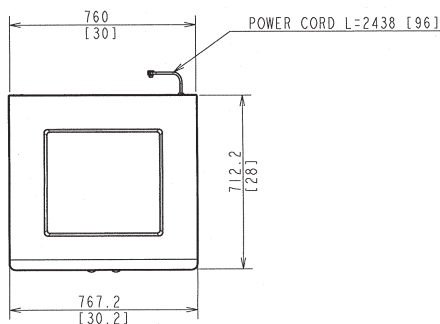

Unique auger agitator design dispenses individual cubes.